

DATA SHEET

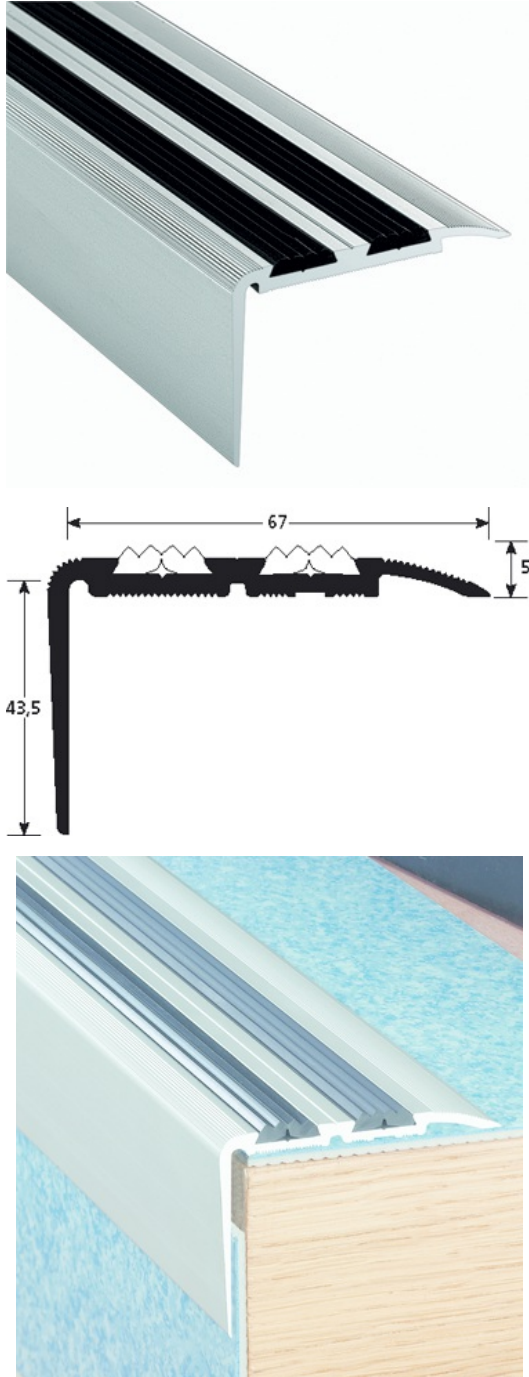

DESCRIPTION

Aluminium stair-nosing with anti-slip PVC insert
To secure stairs and reduce slip risk
Drilled - countersunk: to be screwed
18 holes, first and last one at 83 mm
Holes are drilled, countersunk and deburred
For available inserts, see ROMUS catalogue

USE

For overlapping a floor covering or a parquet or concrete floor.
Indoor use

REFERENCE

Ref : 1330

MATERIAL

Aluminium profile: 6060-T5, N755-2 top-of-the-range alloy, thermally treated for higher hardness. Anodised 15 micron. Black anti-slip PVC insert
REACH compliant

FITTING MODE

Cut the profile to the desired length. Locate the holes and drill into the concrete. Place the ROMUS plugs 94154. Position the profile and fasten with screws 94137. Then insert the anti-slip PVC insert.

The information contained in this document is provided for information purposes. Romus cannot be held liable for this information. The user or specifier will check the compatibility of the product technical data with the actual situation. Romus reserves the right to modify all or part of this document without prior notice.

Architect :

Project :

Email :

Tel :

Distributor :

Tel :

Email :

DATA SHEET

> MAINTENANCE

For daily cleaning, use standard detergents. In case you want to use a sodium, ammoniac or acid based cleaner, carry first out a preliminary test on the profile, avoiding the insert.

The information contained in this document is provided for information purposes. Romus cannot be held liable for this information. The user or specifier will check the compatibility of the product technical data with the actual situation. Romus reserves the right to modify all or part of this document without prior notice.

Architect :

Project :

Email :

Tel :

Distributor :

Tel :

Email :